

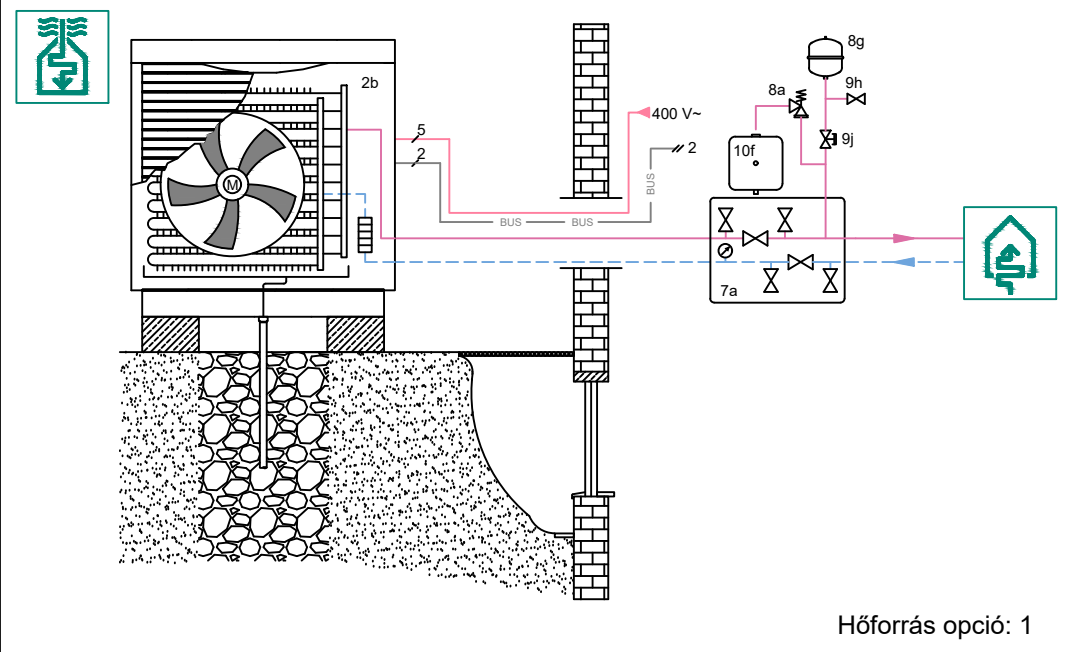

Hőforrás opciók : 1,2,3,4,5  
 Figyelem: hőforrás opció: 2  
 - az egységek hidraulikus bekötése Tichelmann elv szerint  
 - aroCOLLECT 1-es egység: eBUS cím az 1-es helyzetben  
 - aroCOLLECT 2-es egység: eBUS cím az 2-es helyzetben

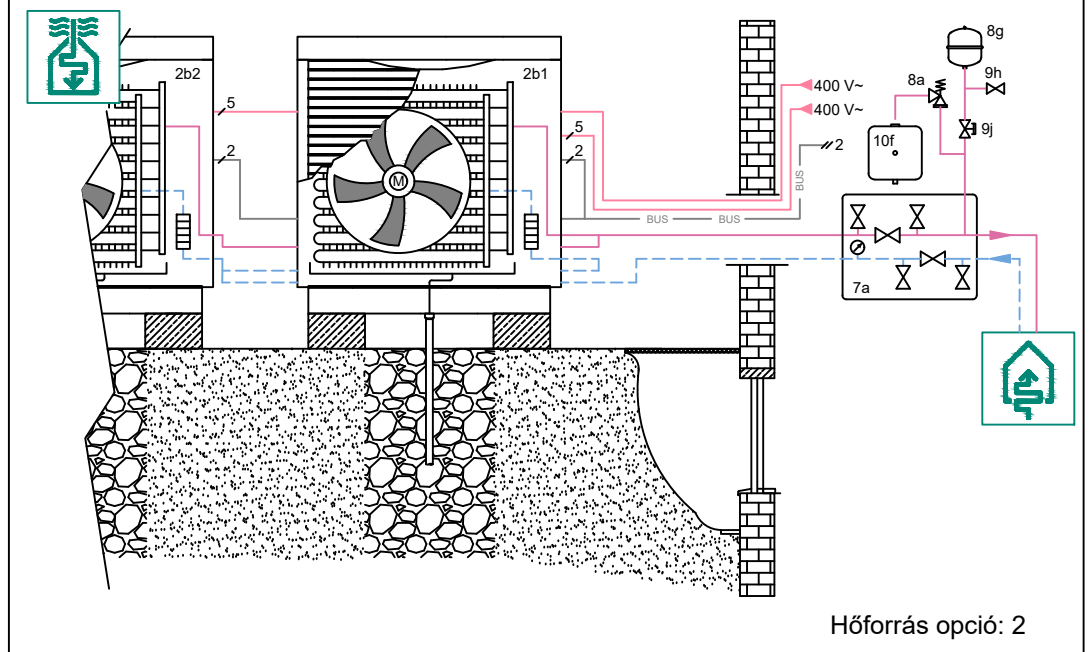

Hőforrás opció: 1



Hőforrás opció: 2

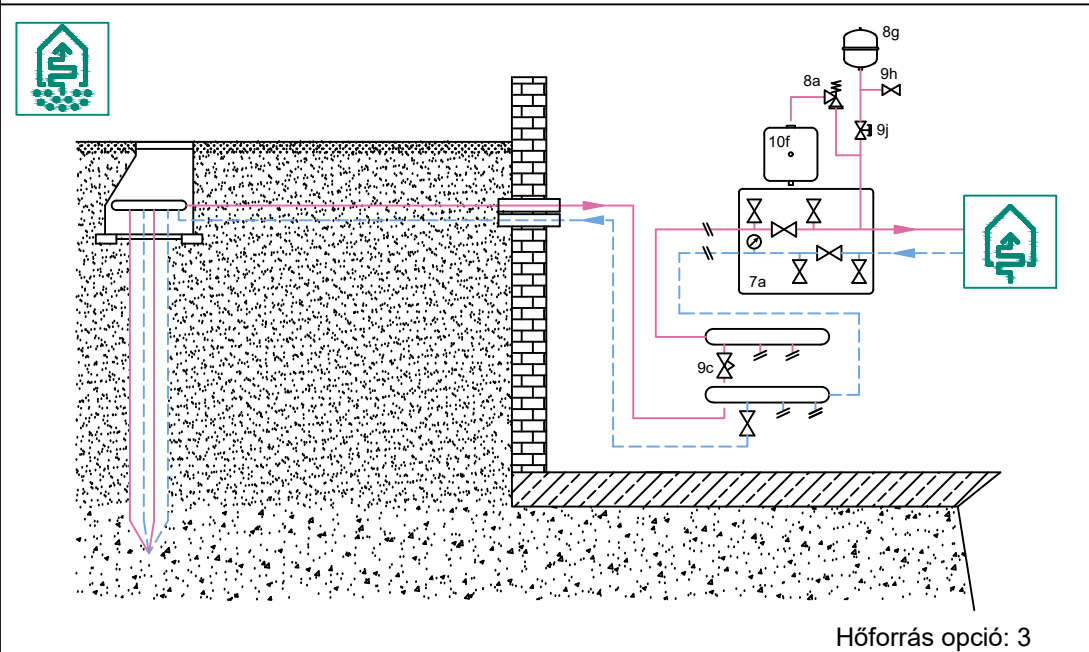

Hőforrás opció: 3

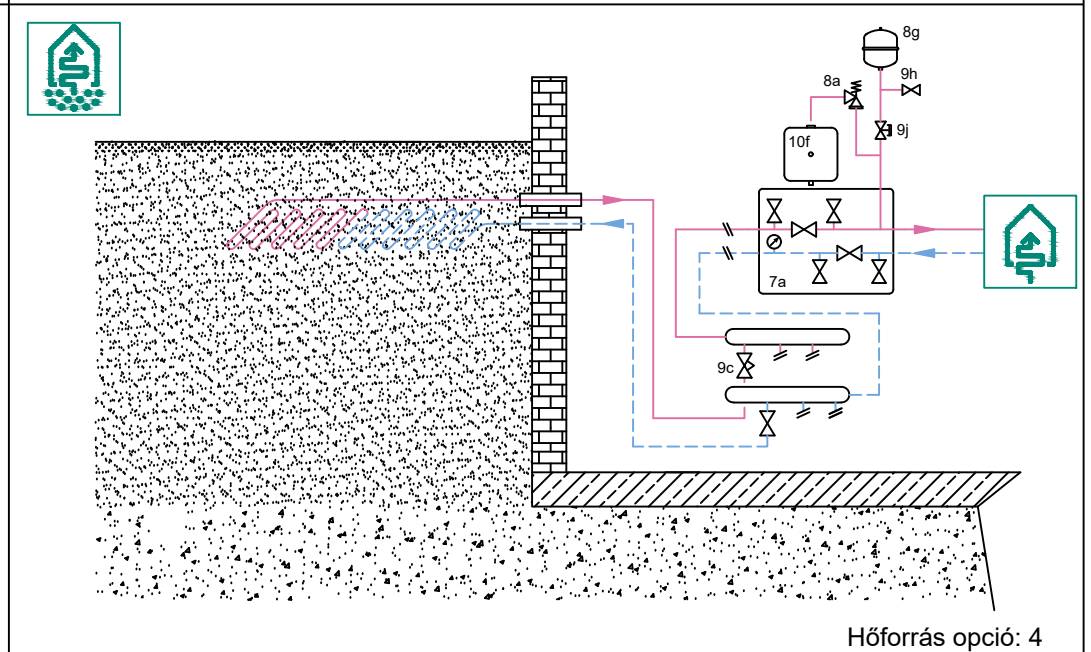

Hőforrás opció: 4

Attention, this principal scheme does not supersede a correct professional design of the system!  
 This scheme does not include all necessary shut-off and safety devices for a right installation.  
 The applicable national and international laws, regulations, standards and directives must be adhered to!

drawn: ACÓ  
 date: 26.10.2018

version no. 05.00  
 reference to

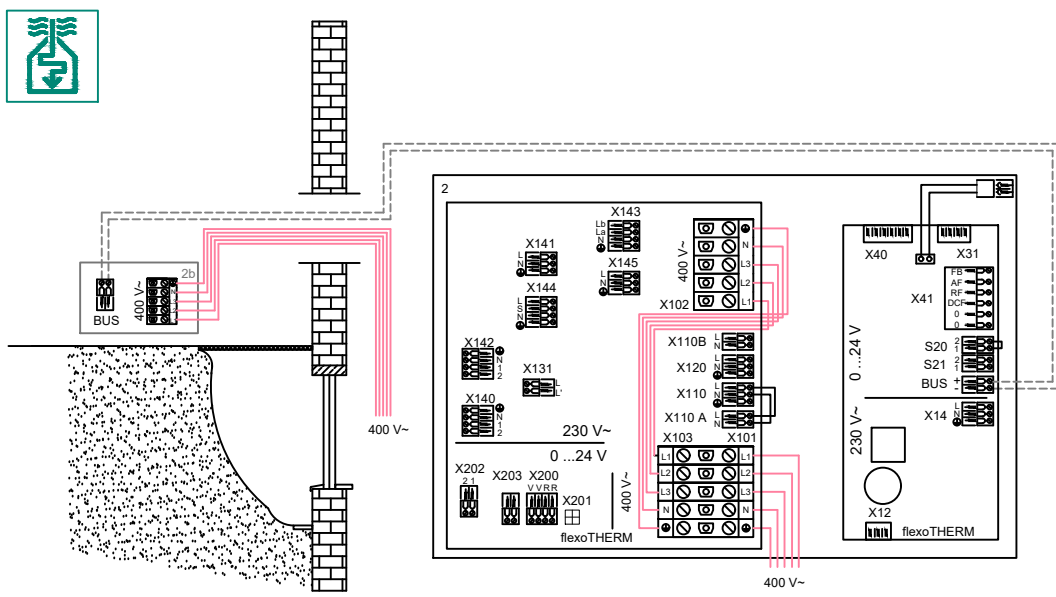

Hőforrás opció: 1

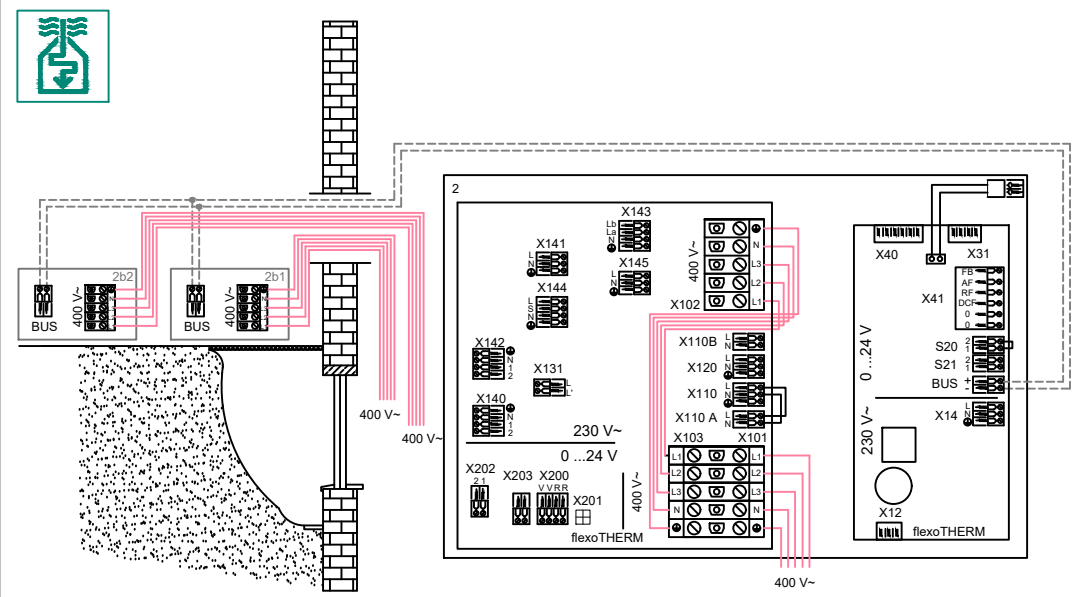

Hőforrás opció: 2

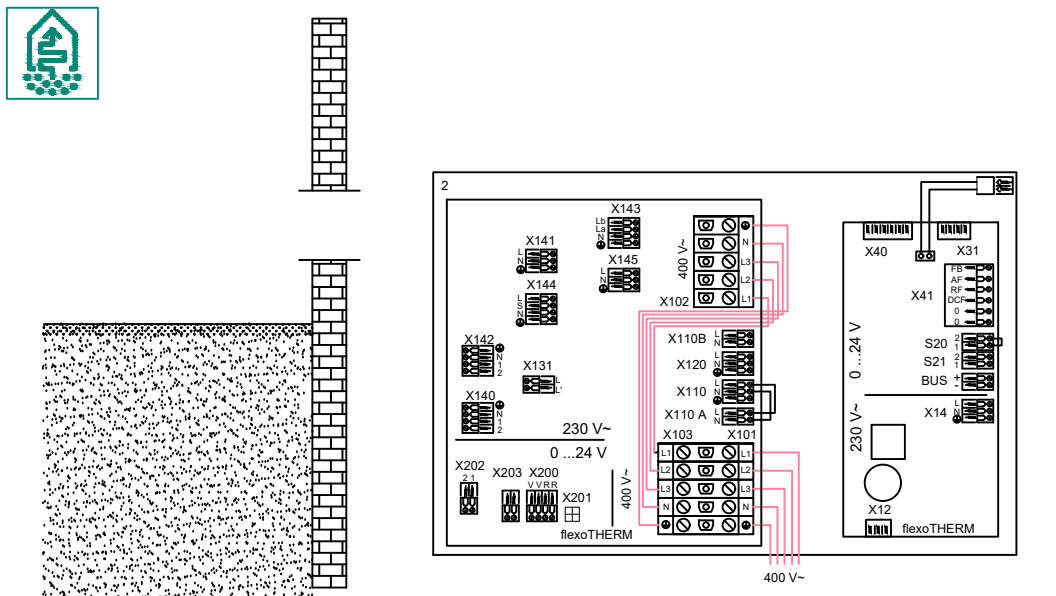

Hőforrás opció: 3

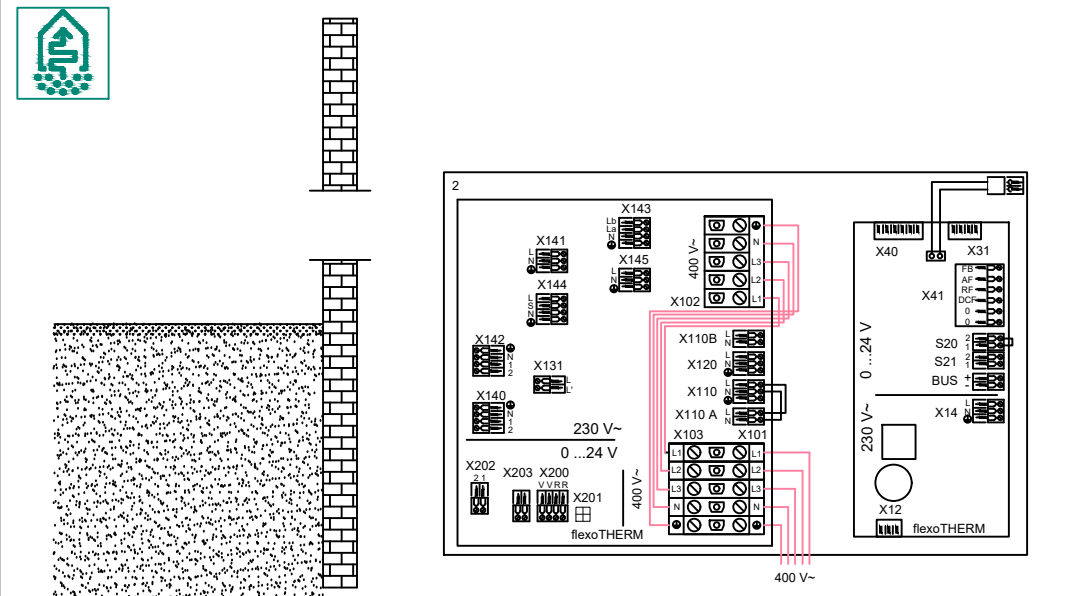

Hőforrás opció: 4

Figyelem! Ez a rajz egy elvi ábrázolás és nem helyettesíti a szakszerű tervezést! Ez a rajz nem tartalmazza az előírás szerű telepítéshez szükséges összes elzáró szelepet és biztonsági berendezést! Be kell tartani az érvényben lévő nemzeti és nemzetközi szabványokat, illetve irányelveket is!

rajzolta: ACO	verziószám	05.00
dátum: 26.10.2018	referencia	

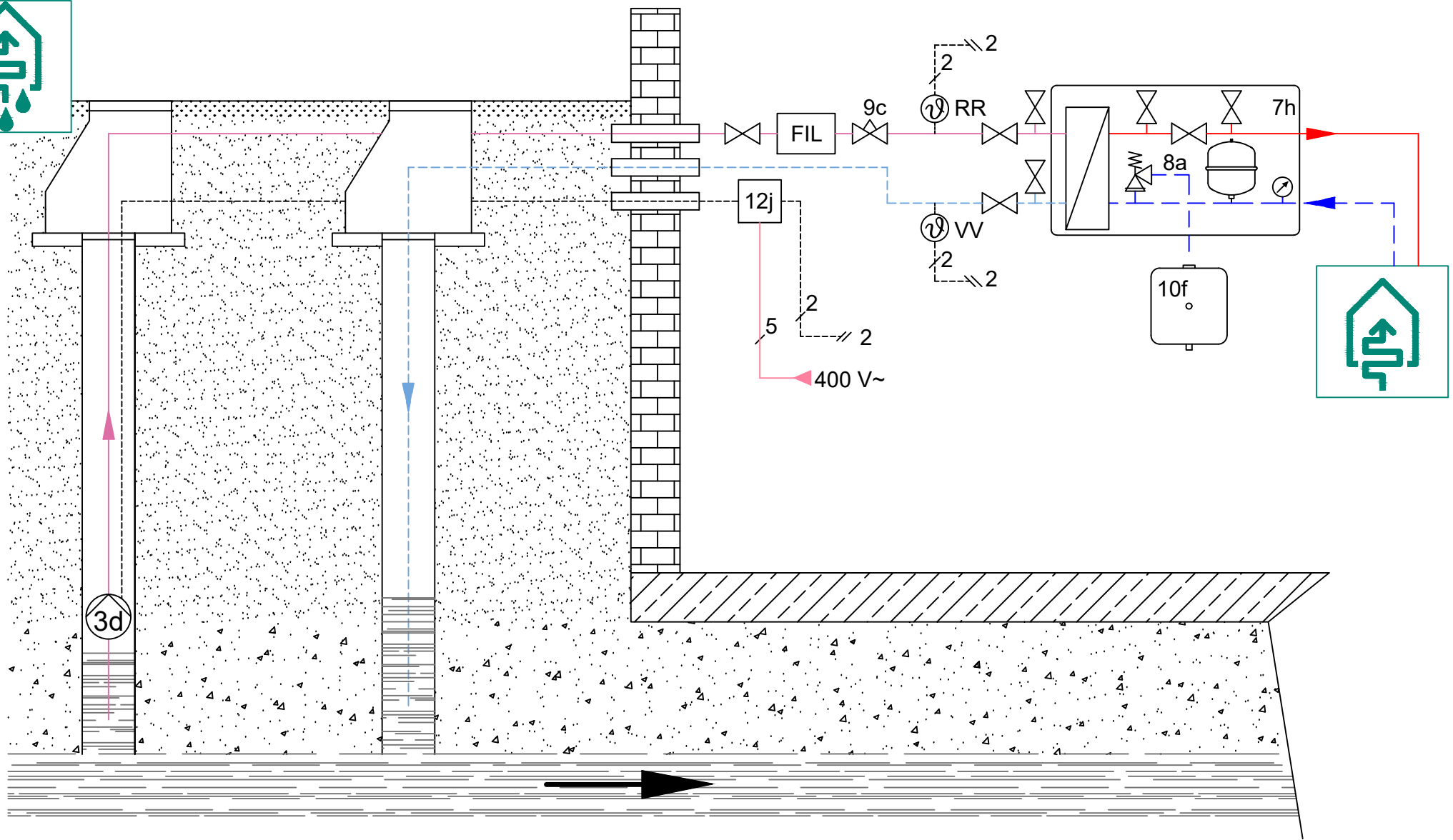

Hőforrás opció: 5

Figyelem! Ez a rajz egy elvi ábrázolás és nem helyettesíti a szakszerű tervezést! Ez a rajz nem tartalmazza az előírás szerű telepítéshez szükséges összes elzáró szelepet és biztonsági berendezést! Be kell tartani az érvényben lévő nemzeti és nemzetközi szabványokat, illetve irányelveket is!

rajzolta: ACÓ	verziószám	05.00
dátum: 26.10.2018	referencia	

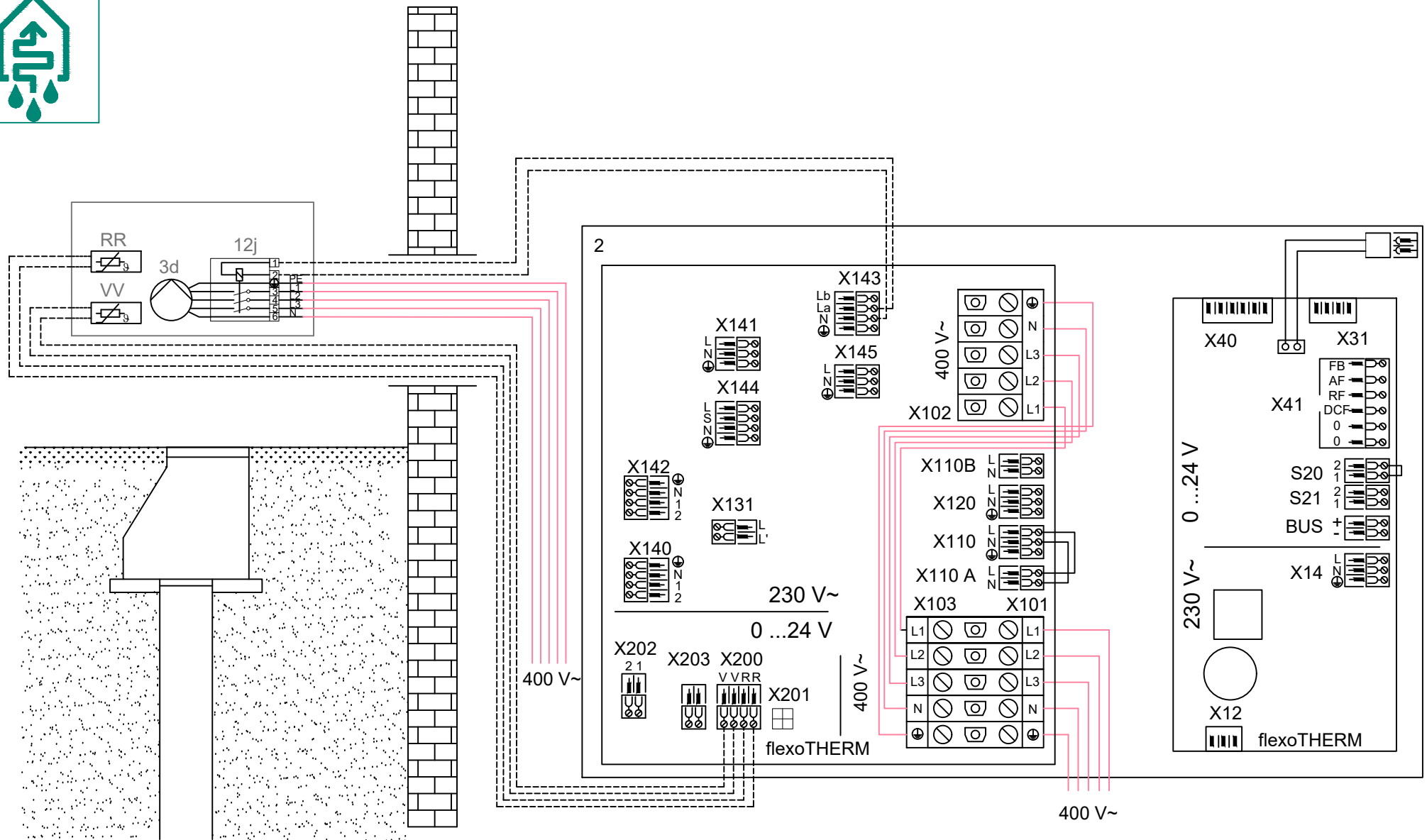

### Hőforrás opció: 5

Figyelem! Ez a rajz egy elvi ábrázolás és nem helyettesíti a szakszerű tervezést! Ez a rajz nem tartalmazza az előírás szerű telepítéshez szükséges összes elzáró szelepet és biztonsági berendezést! Be kell tartani az érvényben lévő nemzeti és nemzetközi szabványokat, illetve irányelveket is!

rajzolta: ACO	verziószám	05.00
dátum: 26.10.2018	referencia	

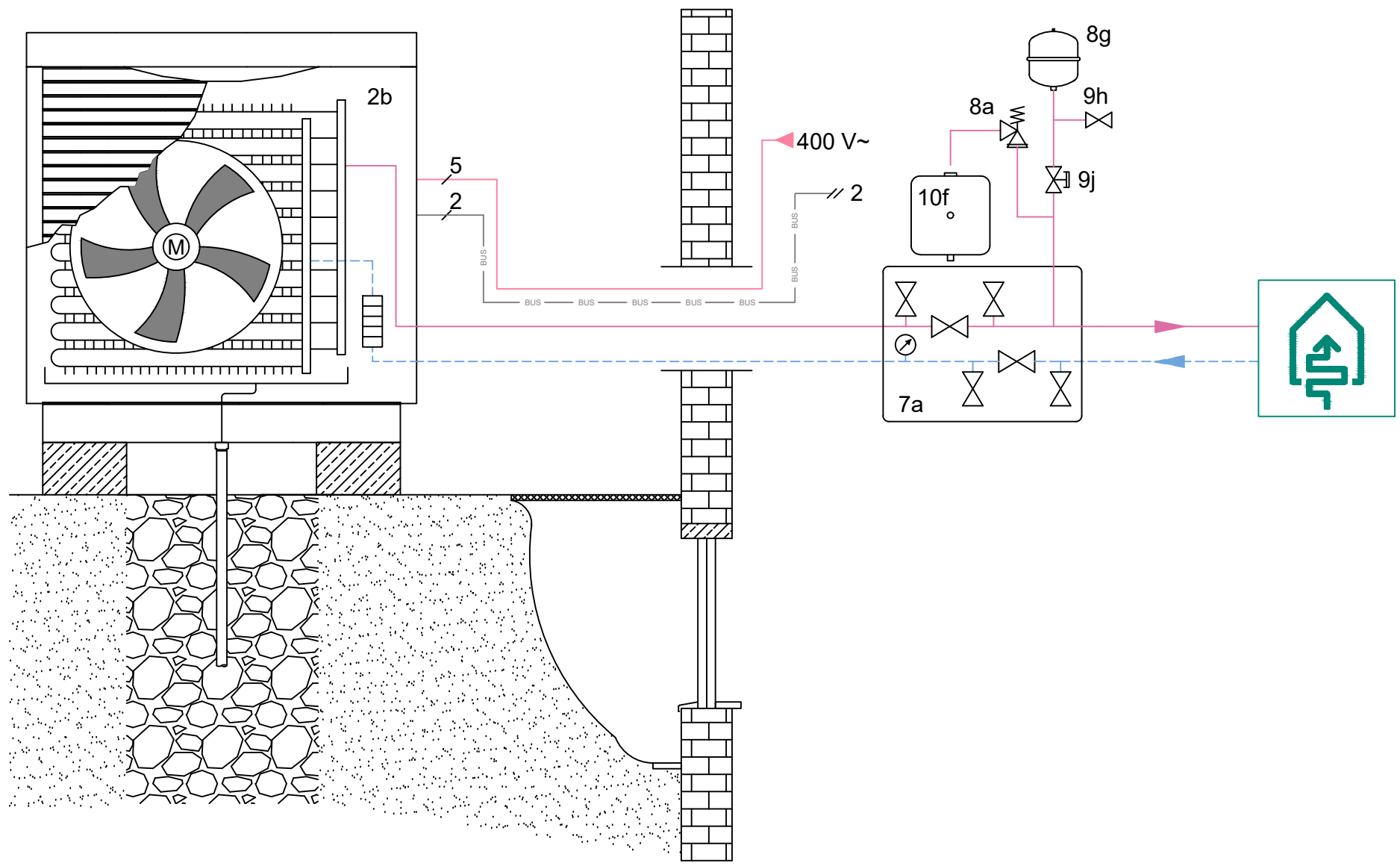

Hőforrás opció: 1

Figyelem! Ez a rajz egy elvi ábrázolás és nem helyettesíti a szakszerű tervezést! Ez a rajz nem tartalmazza az előírás szerű telepítéshez szükséges összes elzáró szelepet és biztonsági berendezést! Be kell tartani az érvényben lévő nemzeti és nemzetközi szabványokat, illetve irányelveket is!

rajzolta: ACO	verziószám	05.00
dátum: 26.10.2018	referencia	

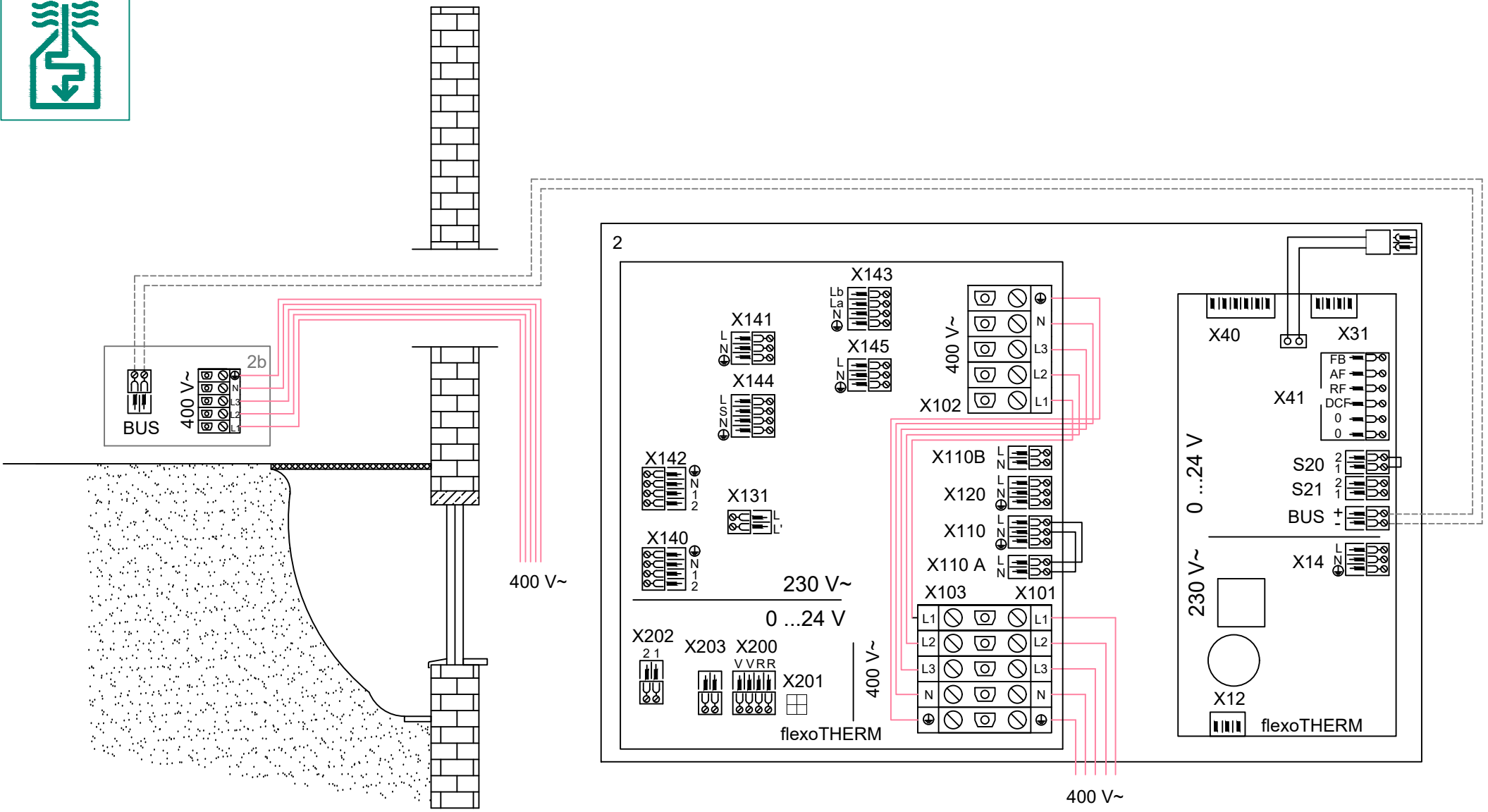

Hőforrás opció: 1

Figyelem! Ez a rajz egy elvi ábrázolás és nem helyettesíti a szakember tervezését! Ez a rajz nem tartalmazza az előírás szerű telepítéshez szükséges összes elzáró szelepet és biztonsági berendezést! Be kell tartani az érvényben lévő nemzeti és nemzetközi szabványokat, illetve irányelveket is!

rajzolta: ACÓ	verziószám	05.00
dátum: 26.10.2018	referencia	

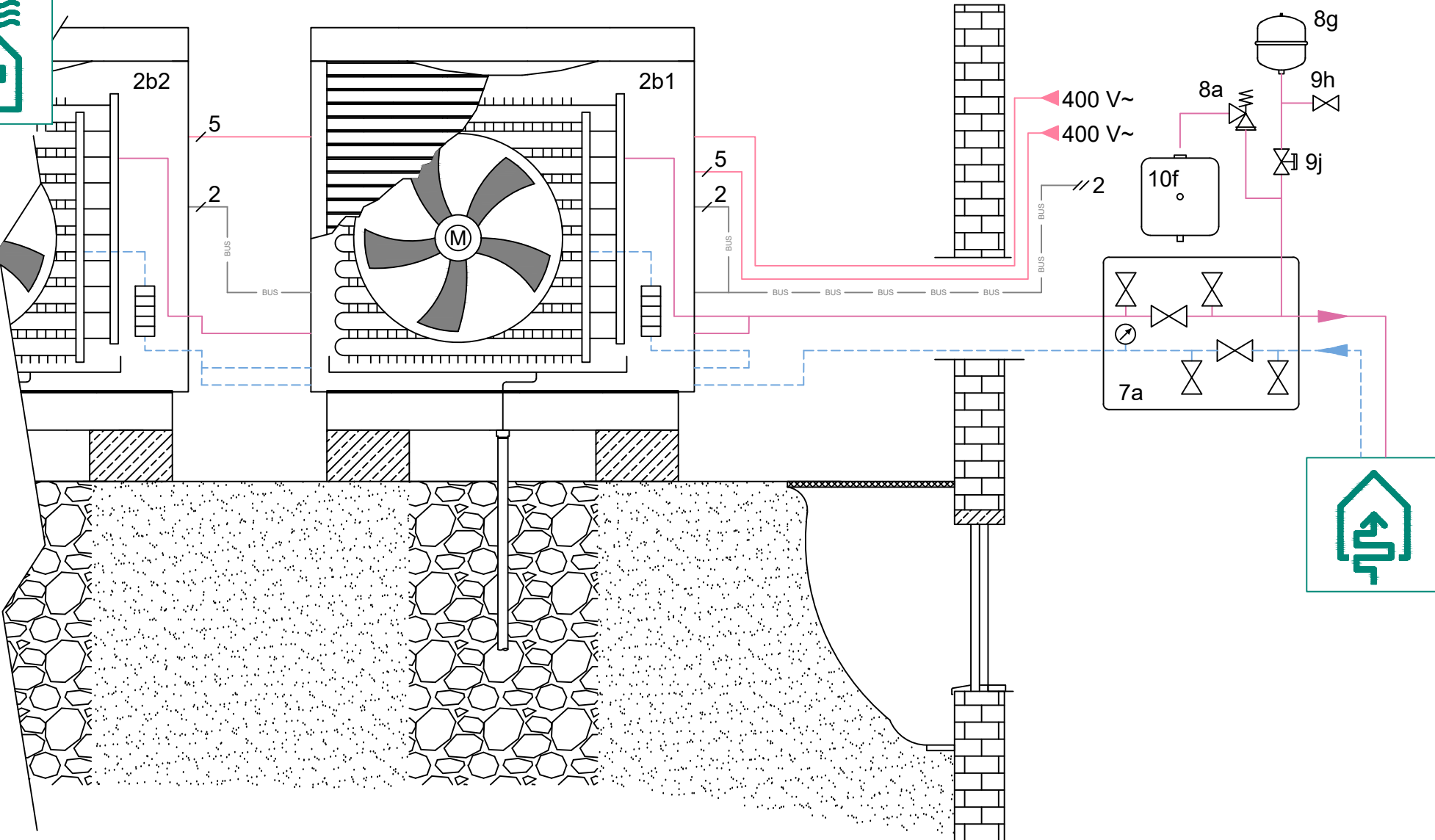

Hőforrás opció: 2

Figyelem! Ez a rajz egy elvi ábrázolás és nem helyettesíti a szakszerű tervezést! Ez a rajz nem tartalmazza az előírás szerű telepítéshez szükséges összes elzáró szelepet és biztonsági berendezést! Be kell tartani az érvényben lévő nemzeti és nemzetközi szabványokat, illetve irányelveket is!

rajzolta: ACÓ	verziószám	05.00
dátum: 26.10.2018	referencia	

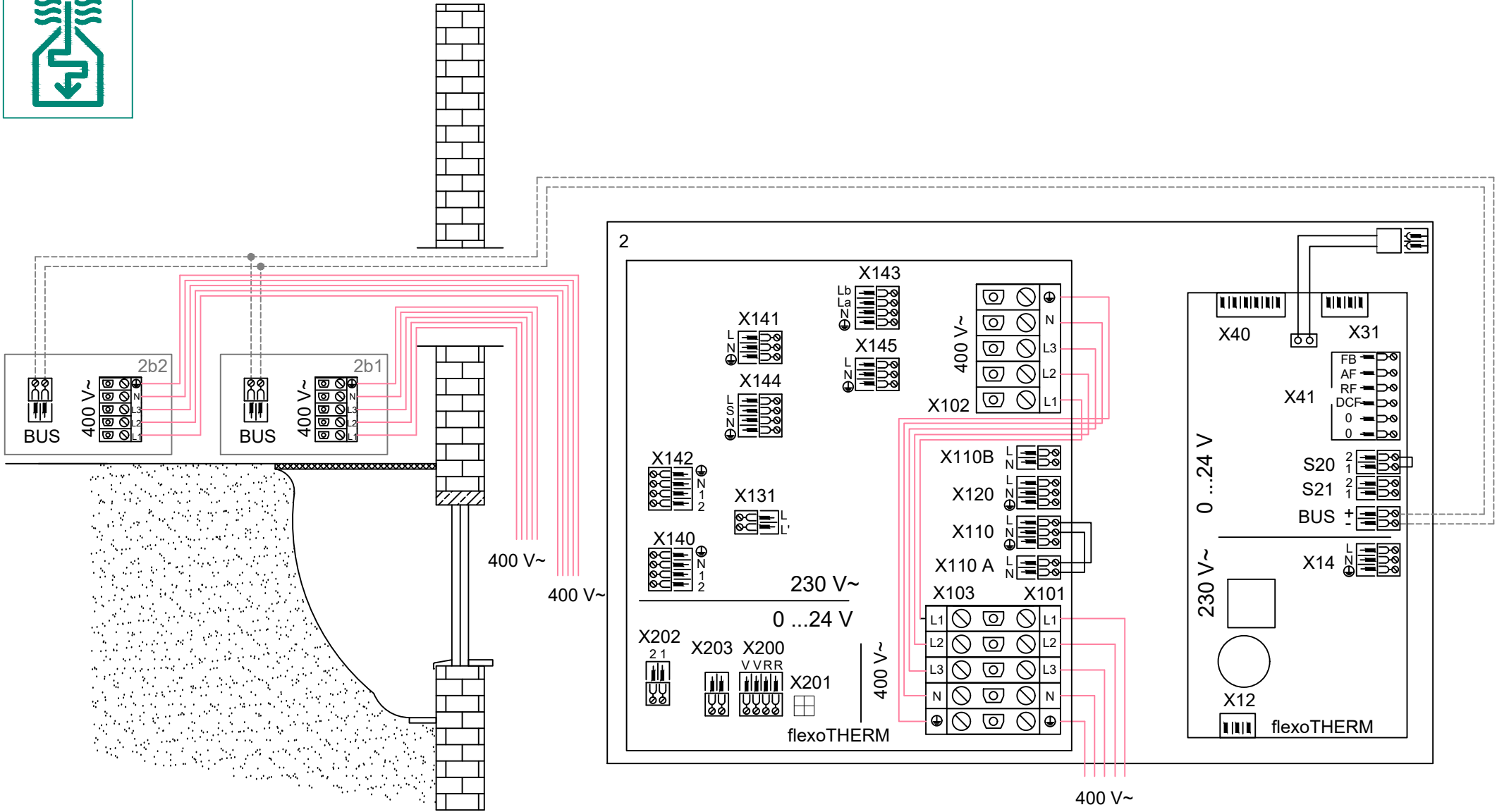
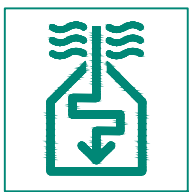

## Hőforrás opció: 2

Figyelem! Ez a rajz egy elvi ábrázolás és nem helyettesíti a szakszerű tervezést! Ez a rajz nem tartalmazza az előírás szerinti telepítéshez szükséges összes elzáró szelepet és biztonsági berendezést! Be kell tartani az érvényben lévő nemzeti és nemzetközi szabványokat, illetve irányelveket is!

rajzolta: ACÓ	verziószám	05.00
dátum: 26.10.2018	referencia	



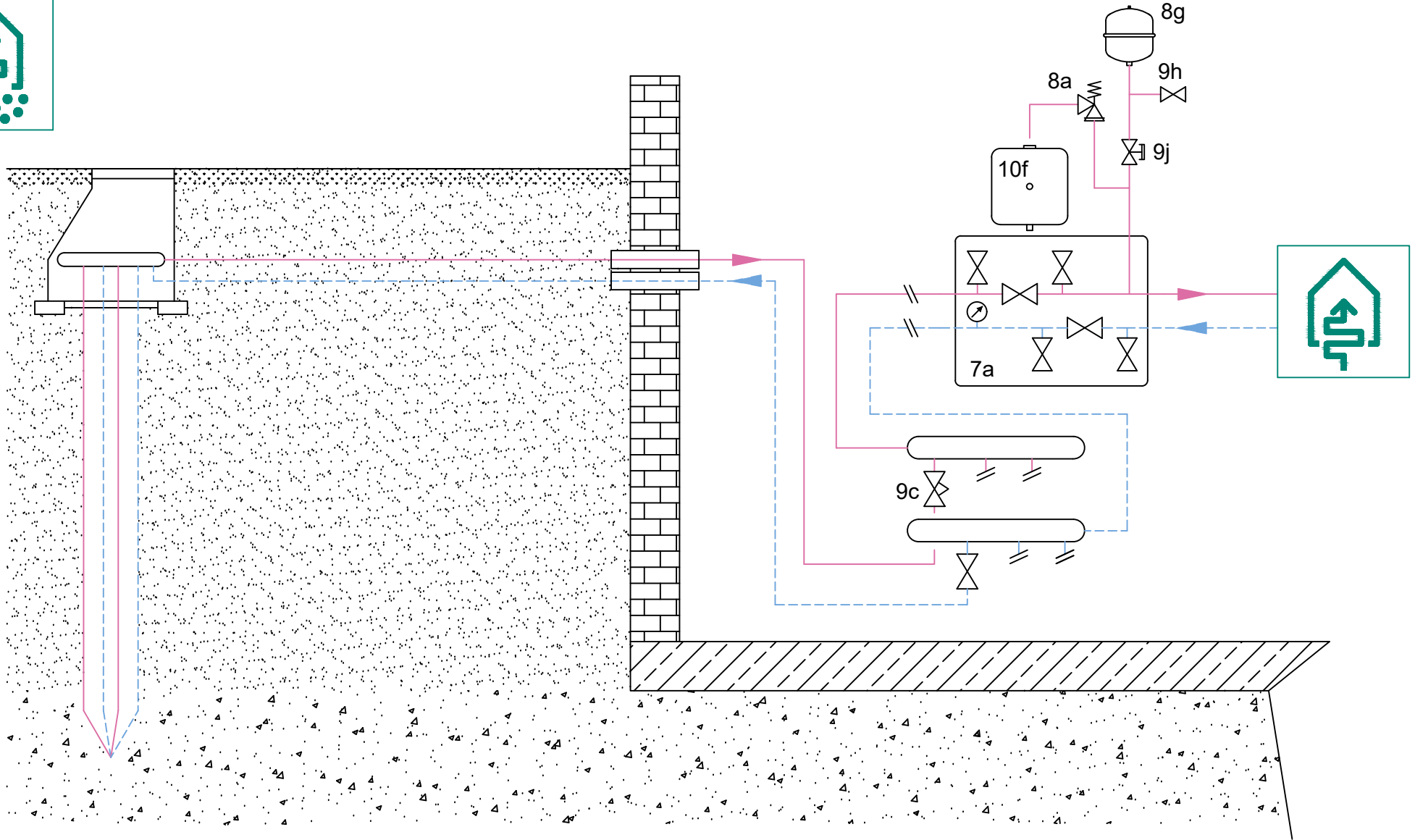

Hőforrás opció: 3

Attention, this principal scheme does not supersede a correct professional design of the system!  
This scheme does not include all necessary shut-off and safety devices for a right installation.  
The applicable national and international laws, regulations, standards and directives must be adhered to!

drawn: ACÖ	version no.	05.00
date: 26.10.2018	reference to	

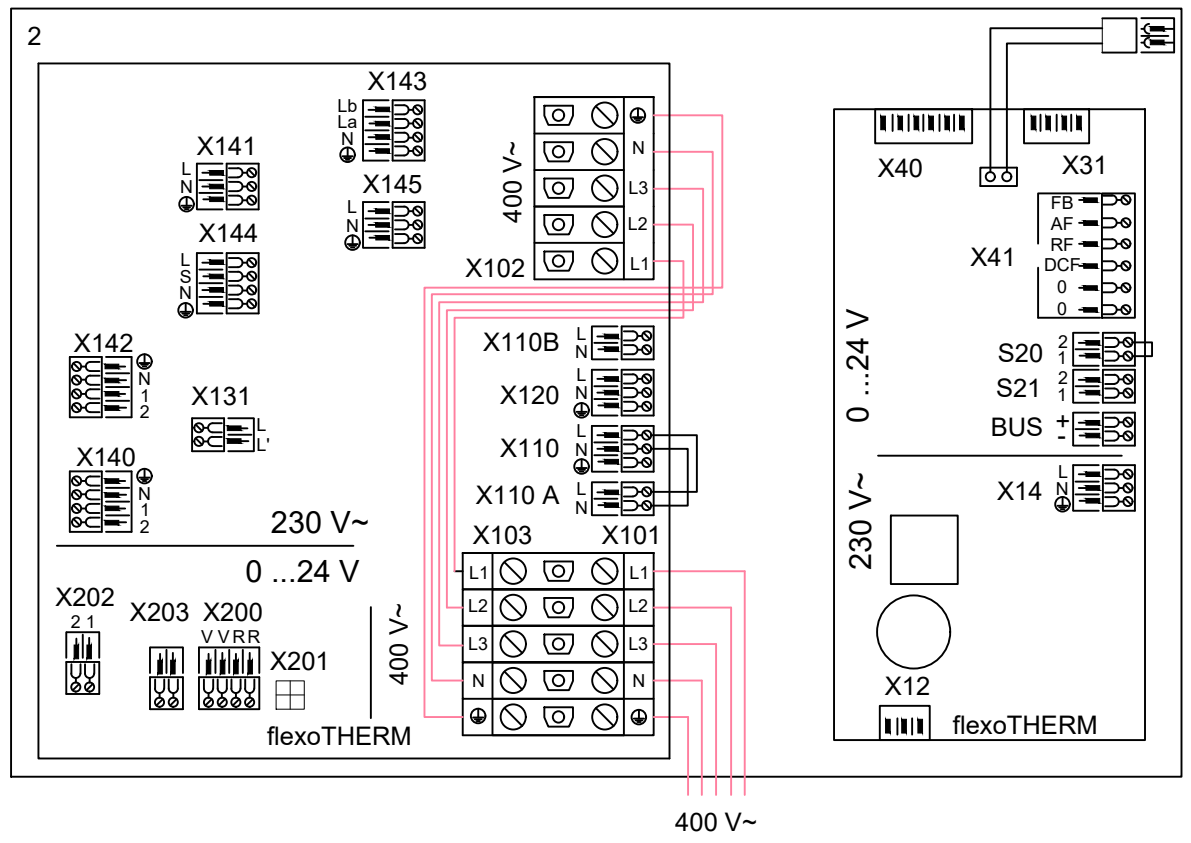
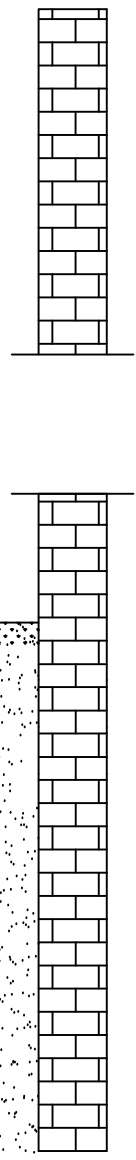

### Hőforrás opció: 3

Attention, this principal scheme does not supersede a correct professional design of the system! This scheme does not include all necessary shut-off and safety devices for a right installation. The applicable national and international laws, regulations, standards and directives must be adhered to!

drawn: ACÖ	version no.	05.00
date: 26.10.2018	reference to	

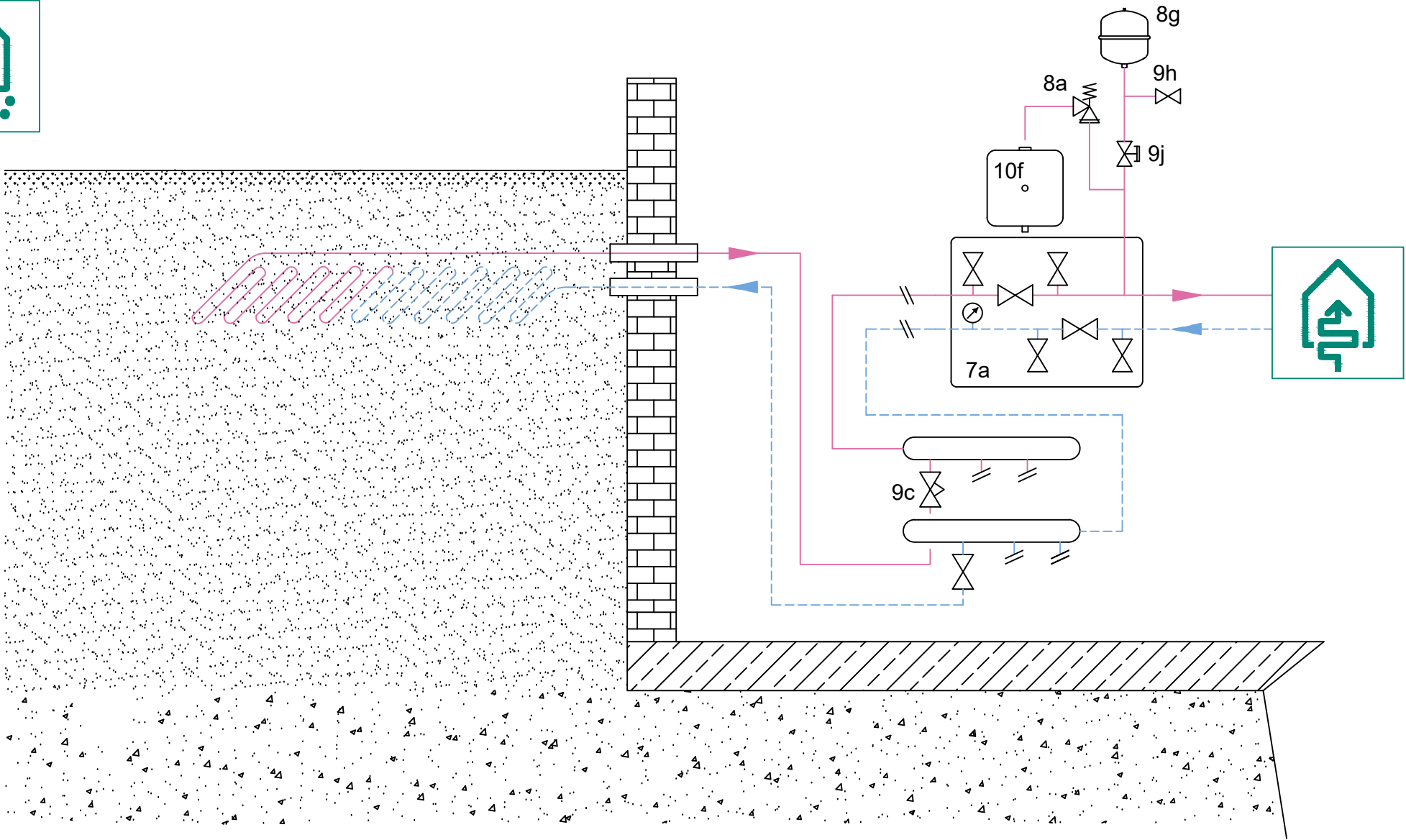

Hőforrás opció: 4

Attention, this principal scheme does not supersede a correct professional design of the system!  
 This scheme does not include all necessary shut-off and safety devices for a right installation.  
 The applicable national and international laws, regulations, standards and directives must be adhered to!

drawn: ACÖ	version no.	05.00
date: 26.10.2018	reference to	

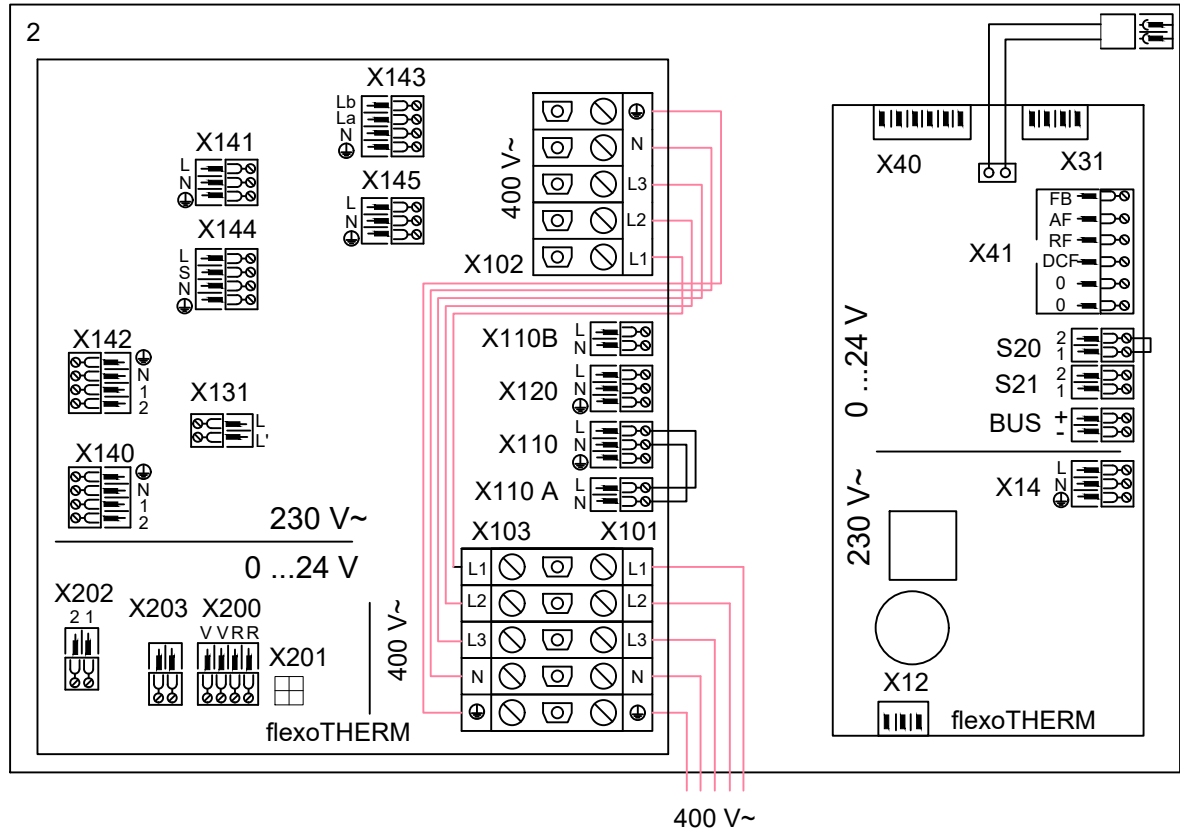
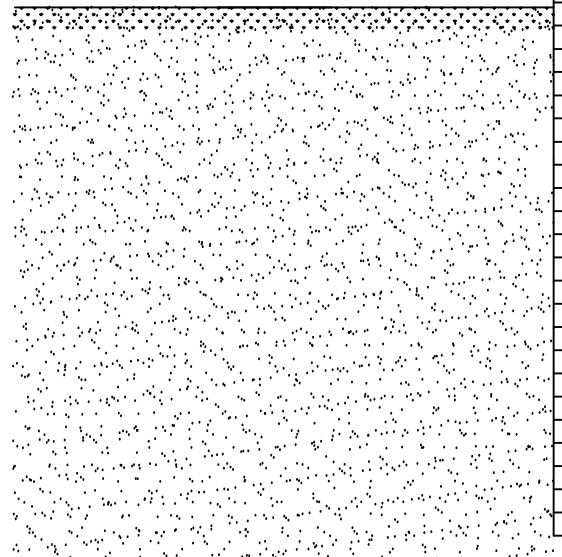
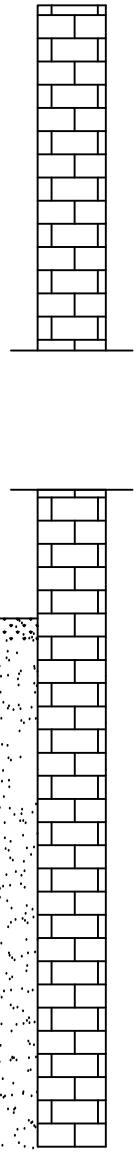

Hőforrás opció: 4

Attention, this principal scheme does not supersede a correct professional design of the system!  
 This scheme does not include all necessary shut-off and safety devices for a right installation.  
 The applicable national and international laws, regulations, standards and directives must be adhered to!

drawn: ACÖ	version no.	05.00
date: 26.10.2018	reference to	

# Legend



Hydraulic	
1	Heat generator
1a	Domestic hot water auxiliary heater
1b	Heating auxiliary heater
1c	Heating/domestic hot water auxiliary heater
1d	Solid fuel boiler with manual feed
2	Heat pump
2a	Air-to-water heat pump
2b	Air/brine heat exchanger
2c	Split heat pump outdoor unit
2d	Split heat pump inner unit
2e	Groundwater module
2f	Passive cooling module
3	Heat generator circulation pump
3a	Swimming pool circulation pump
3b	Cooling circuit pump
3c	Cylinder charging pump
3d	Well pump
3e	Circulation pump
3f	Heating pump
3g	Heat source circulation pump
3h	Legionella protection pump
3i	Heat exchanger pump
4	Buffer cylinder
5	Monovalent domestic hot water cylinder
5a	Bivalent domestic hot water cylinder
5b	Shift-load domestic hot water cylinder
5c	Combi cylinder
5d	Multi-functional cylinder
5e	Complete heating and hot water module
6	Solar collector (thermal)
7a	Heat pump brine filling unit
7b	Solar pump unit
7c	Domestic hot water station
7d	Home unit
7e	Hydraulic block
7f	Hydraulic module
7g	Heat recovery module
7h	Heat exchanger module
7i	2-zone module
7j	Pump group
8a	Expansion relief valve
8b	Potable water expansion relief valve
8c	Safety group - potable water connection
8d	Boiler safety group
8e	Heating diaphragm expansion vessel
8f	Diaphragm expansion vessel for potable water
8g	Solar / brine diaphragm expansion vessel
8h	Solar in-line vessel
8i	Thermal discharge safety device
9a	Individual room control valve (thermostatic/motorized)
9b	Zone valve
9c	Flow regulator valve
9d	Bypass valve
9e	Hot water generation prioritising diverter valve
9f	Cooling prioritising diverter valve
9g	Diverter valve
9h	Filling / draining cock
9i	Purging valve
9j	Tamper-proof capped valve
9k	3-way mixer
9l	Cooling 3-port mixing valve
9m	Increase in return flow for 3-way mixer
9n	Thermostatic mixing valve
9o	Flow meter (Taco-Setter)
9p	Cascade valve
10a	Thermometer
10b	Pressure gauge
10c	Non-return valve
10d	Air separator
10e	Dirt trap with magnetite separator
10f	Solar/brine collecting container
10g	Heat exchanger
10h	Low loss header
10i	Flexible connections
11a	Fan coil
11b	Swimming pool
12	System control
12a	Remote control unit
12b	Heat pump extension module
12c	2 in 7 multi-functional module
12d	Extension / mixer module
12e	Main extension module
12f	Wiring box
12g	eBUS coupler
12h	Solar controller
12i	External controller
12j	Cut-off relay
12k	Limit thermostat
12l	Cylinder temperature limiter
12m	Outdoor temperature sensor
12n	Flow switch
12o	eBUS power supply unit
12p	Radio receiver unit
13	Ventilation unit
14a	Silencer
14b	Fire protection flap
14c	Air intake
14d	Restrictor flap
14e	Air diverter
14f	Extract air device
14g	Air collector
14h	Air filter
14i	Air diverter with inspection opening
14j	Radial fan
14k	Bypass flap

### Wiring

BufBt	Bottom temperature sensor of buffer cylinder
BufTopDHW	Top temperature sensor for DHW section of buffer cylinder
BufBtDHW	Bottom temperature sensor for DHW section of buffer cylinder
BufTopCH	Top temperature sensor for heating section of buffer cylinder
BufBtCH	Bottom temperature sensor for heating section of buffer cylinder
C1/C2	Enable cylinder charging / buffer charging
COL	Collector temperature sensor
DEM	External heating demand for the heating circuit
DHW	Cylinder temperature sensor
DHWBt	Bottom cylinder temperature sensor (domestic hot water cylinder)
EVU	Energy supply company switching contact
FS	Heating circuit flow temperature sensor/ swimming pool sensor
MA	Multi-function output
ME	Multi-function input
PWM	PWM signal for pump
PV	Photovoltaic inverter interface
RT	Room thermostat
SCA	Cooling signal
SG	Transmission system operator interface
Solar yield	Solar yield sensor
SysFlow	System temperature sensor
TD	Temperature sensor for ΔT control system
TEL	Switch input for remote control
TR	Isolating circuit with switching floor-standing boiler

Multiple use components (x) are serially numbered (x1, x2, ..., xn).

Potable water	—	Solar water	—	Brine flow (from source)	—	Refrigerant low pressure	—
Domestic hot water	---	Solar return	---	Brine return (to source)	---	Extract Air	---
DHW circulation	—	Electrical wiring	----	Cooling flow	---	Outdoor Air	—
Heating flow	—	Power supply 230/400V	—	Cooling return	---	Recirculation Air	---
Heating return	---	eBus connection	—BUS—	Refrigerant high pressure	—	Supply Air	—

**Attention: This principal scheme does not supersede a real planning!** This scheme does not include all necessary valves and safety devices for a right installation. The actual applicable national and international standards and regulations have to be attended.

Confidential: A communication to a third party in any form is not permitted without written consent from Vaillant.

## Caution! Schematic diagram!

1. Non-binding recommendation! The information below shall never supersede the correct professional design of the system. This system schematic does not include all the shut-off and safety devices necessary for professional assembly. The applicable national and international laws and regulations, standards and directives must be adhered to!
2. Subject to alterations in the schematic diagram! Full and/or partial reproduction of this schematic is subject to prior written approval by Vaillant GmbH.
3. During planning and design, installation and later use of the system, all operating instructions for installation and use created and applicable to the appliance, the accessories and/or all other system components must be adhered to.
4. Vaillant GmbH herewith strictly rules out any liability for claims for damages on whatever legal ground, especially for breach of obligations or delictual obligation, i.e. claims in tort. The aforesaid shall neither apply in cases of statutory liability, wilful intent or gross negligence, nor in case of injury to life, body or health nor in the case of violation of material contractual obligations (cardinal obligations) provided that a contract is concluded with the user of the schematic diagram hereunder. Cardinal obligations are material obligations or duties to be warranted by the contract in accordance with its subject or purpose; furthermore material contractual obligations are such obligations indispensable for the correct performance of such contract in the first place; the customer constantly trusts in and is entitled to trust in the adherence to such obligations. However, liability for claims for damages due to breach of such material contractual obligations shall be limited to the foreseeable damages typical with the respective contract unless such breach is a case of wilful intent or gross negligence or in case of liability due to injury to life, body or health. The aforesaid stipulations shall not entail any change in the burden of proof to the disadvantage of the user of the schematic diagram hereunder.

### Legionella protection:

- ▲1 The system doesn't fulfill the hygienic requirements acc. to DIN 1988-200: 2012-5 (legionella protection).
- ▲2 Legionella protection function to be arranged by boilers with system control.
- ▲3 The system fulfills the hygienic requirements acc. to DIN 1988-200: 2012-5 (legionella protection) only with integrated electric peak heater or with system temperature  $\leq 60^{\circ}\text{C}$ .

### Solar:

- ▲4 The connection of an external solar yield sensor is not possible.
- ▲5 The connection of a controlled solar unit is not possible.
- ▲6 Mount the sensor of the overheat safety thermostat at an adequate position to avoid tank temperatures above  $100^{\circ}\text{C}$ .
- ▲7 Safety thermostat 10K has to be installed acc. to DIN EN 60335-1.

### Heat pump:

- ▲8 The heating output of the heat pump has to be aligned with the coil size of the DHW tank.
- ▲9 Use of VIH RW 300 up to maximum heating output of the heat pump of 11 kW.
- ▲10 Use of VIH RW 400 B up to maximum heating output of the heat pump of 7 kW.
- ▲11 Use of VIH RW 400 B up to maximum heating output of the heat pump of 11 kW.
- ▲12 Additional technical requirements for use of low loss header:
  - 1) Heating curve setting: as flat as possible
  - 2) Room temperature set point in each room: min.  $17^{\circ}\text{C}$  (according to DIN EN12831)
  - 3) Type of low loss header shall be aligned to heat pump
- ▲13 Heat source options 0020178458: number 1,2,3,4
- ▲14 Heat source options 0020199566: number 1,2,3
- ▲15 Min. 35 % of the nominal flow rate through the reference room without single room temperature control valve.
- ▲16 An additional heat generator has to be installed to reach the required domestic hot water temperatures acc. the actual standards and directives.
- ▲17 Pump with IF-module is necessary
- ▲18 Reference UV1 002003674

### Boiler:

- ▲19 The connection of an outdoor sensor is possible for SDBG WHB.
- ▲20 For boilers without additional relay on board the DHW circulation pump has to be connected to extension module 2 to 7.
- ▲21 For configurations with DHW circulation pump an additional extension module has to be used.
- ▲22 An additional expansion vessel in the DHW loading circuit of the boiler has to be planned for boilers without integrated expansion vessel.
- ▲23 DHW tank loading simultaneously with heating operation is not possible.

### Cylinder:

- ▲24 Inlet flow rate for cylinder loading (DHW and heating)  $< 1800 \text{ m}^3/\text{h}$ .

### Other:

- ▲25 The flow rate of the connected heat generators has to be aligned with the decoupler module.
- ▲26 Backup heater DHW must be protected by a self acting overheat thermostat.
- ▲27 Backup heater CH must be protected by a self acting overheat thermostat.
- ▲28 Max. 8 addresses for remote controls, solar loading units and DHW generation units.
- ▲29 DHW circulation pump has to be installed separately.
- ▲30 Optional component
- ▲31 The cascade can be configured with 1 to 7 heat generators.
- ▲32 The cascade can be configured with 1 to 4 DHW stations.
- ▲33 The cascade can be configured with 1 to 4 solar stations.
- ▲34 Use the same value for heating curve for HEATING 1 and HEATING 2.
- ▲35 The system can be configured up to 9 mixed circuits.